

BOE

Automated Analysis of Semiconductor Grade BOE with prepFAST S and NexION® 5000 ICPMS

Author: Kevin Wiederin

Introduction

Advances in semiconductor technology and decreasing tolerances in microchip design require simultaneous improvements in both chemical purity and fabrication. As manufacturers move to <10 nm geometry, while seeking improved yield, the chemicals and process reagents must maintain minimal trace metal contamination. The demand for lower detection limits in reagents requires new approaches to sample handling and trace elemental analysis – within the fab and throughout the supply chain.

Buffered oxide etchants (BOEs) are blends of hydrofluoric acid, ammonium fluoride, surfactants, and ultrapure water utilized in the semiconductor industry to etch thin films of silicon wafers. The reduction of potential contamination of silicon wafers during the etching process is crucial, as trace metal, particulate, and organic

contaminants can alter the functionality of semiconductors. At the sub-ppt level, environmental contaminants are difficult to control and can easily contaminate a BOE sample if not properly handled.

The prepFAST S ultraclean sample preparation and introduction system minimizes contamination from the environment and sample handling, enabling semiconductor manufacturers and laboratories to easily analyze these critical samples. The prepFAST S features inline, automated calibration and dilution technology that automates sample and standard preparation. Samples are analyzed directly from their original containers in an exhausted and fully enclosed environment, eliminating manual sampling errors and operator variability and providing sub-ppt detection limits for critical semiconductor elements.



Figure 1. prepFAST S.



prepFAST S

The prepFAST S utilizes a robust PFA probe, CTFE AutoAlign Arm, and sealed PTFE vertical probe drive assembly combined with high-purity, chemically conditioned fluoropolymer flow paths to minimize contamination and maximize chemical resistance. When combined with an exhausted, enclosed sample environment, these features allow automated dilution, acidification, and spiking of concentrated semiconductor chemicals resulting in high-quality calibrations and accurate, precise determination of background equivalent concentrations and detection limits.

Calibrations are generated by automatically spiking from an enclosed multi-element stock standard using either automated

inline method of standard addition (MSA) or external calibration for over 50 elements that are typically controlled in semiconductor manufacturing processes. When combined with the interference reduction modes and multi-quadrupole functionality of the NexION 5000 ICPMS, the result is low to sub-ppt calibrations.

For sample analysis, the prepFAST S allows automatic dilution by volume or weight for direct analysis of concentrated chemicals from their original sample vessels. This feature eliminates sample contamination caused by manual dilution into a secondary container and significantly reduces operator exposure to concentrated and hazardous chemicals.

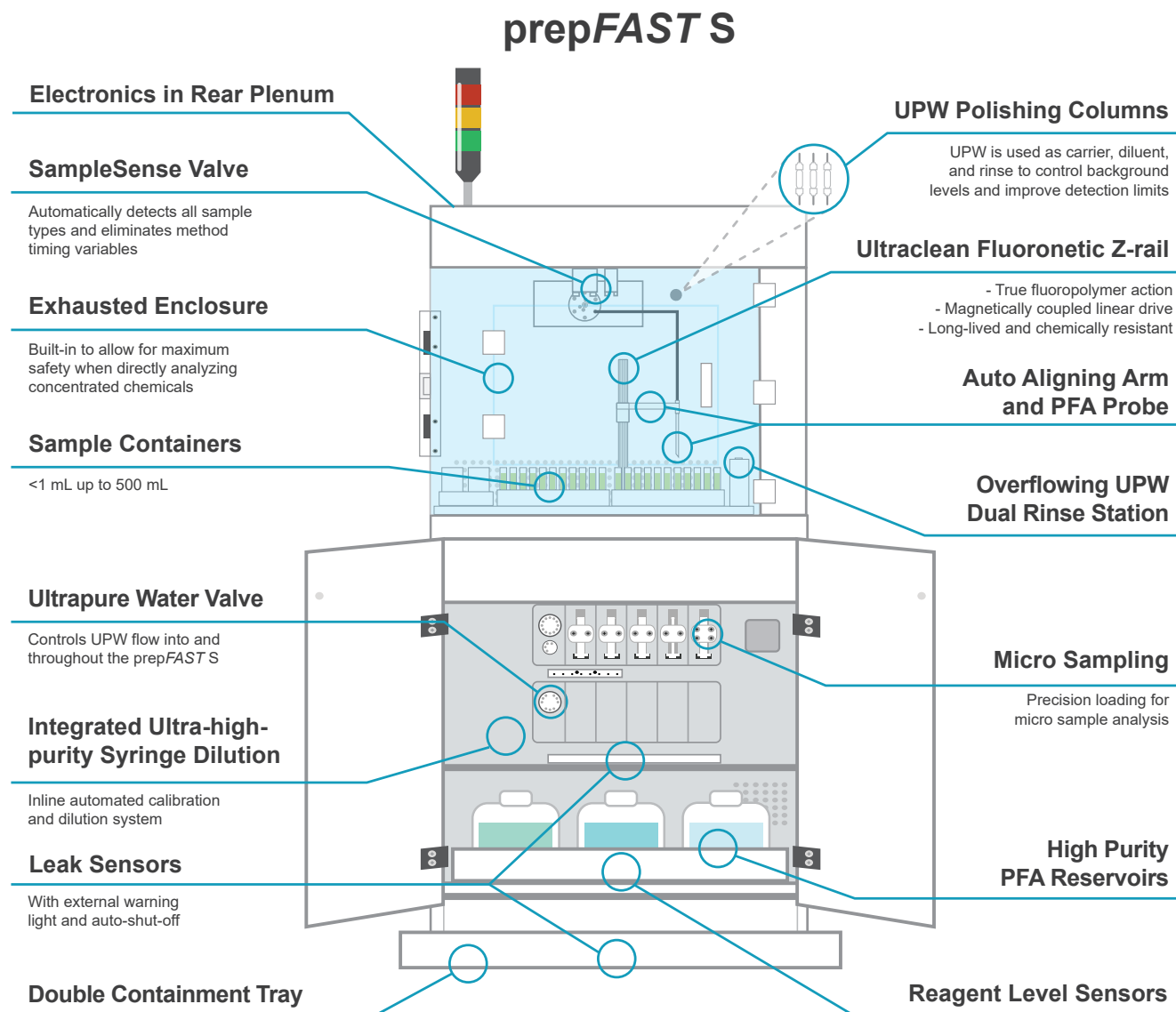

Figure 2. prepFAST S features diagram.

Fluorospray Sample Introduction

The Fluorospray sample introduction kit for the NexION 5000 is a new, HF-resistant technology offering enhanced precision and sensitivity for the analysis of semiconductor-grade ultrapure chemicals. Designed for demanding, multichemical

analysis, the Fluorospray chamber combined with an o-ring free Fluorobore platinum injector provides complete high-performance sample introduction for the semiconductor laboratory.

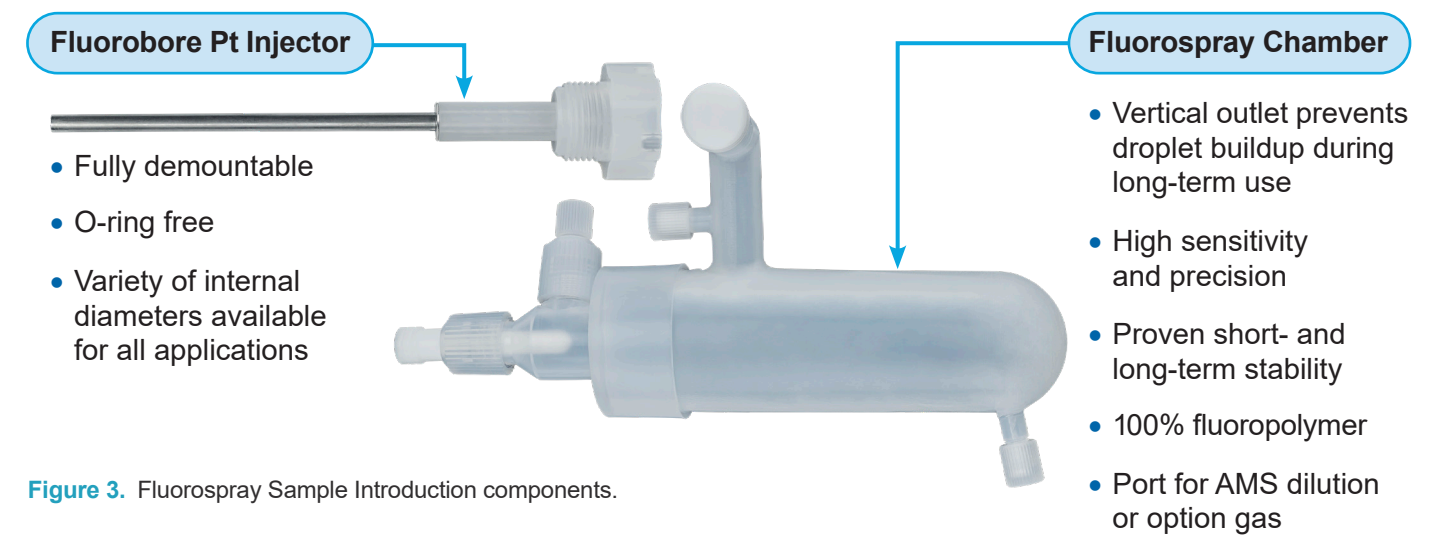

Figure 3. Fluorospray Sample Introduction components.

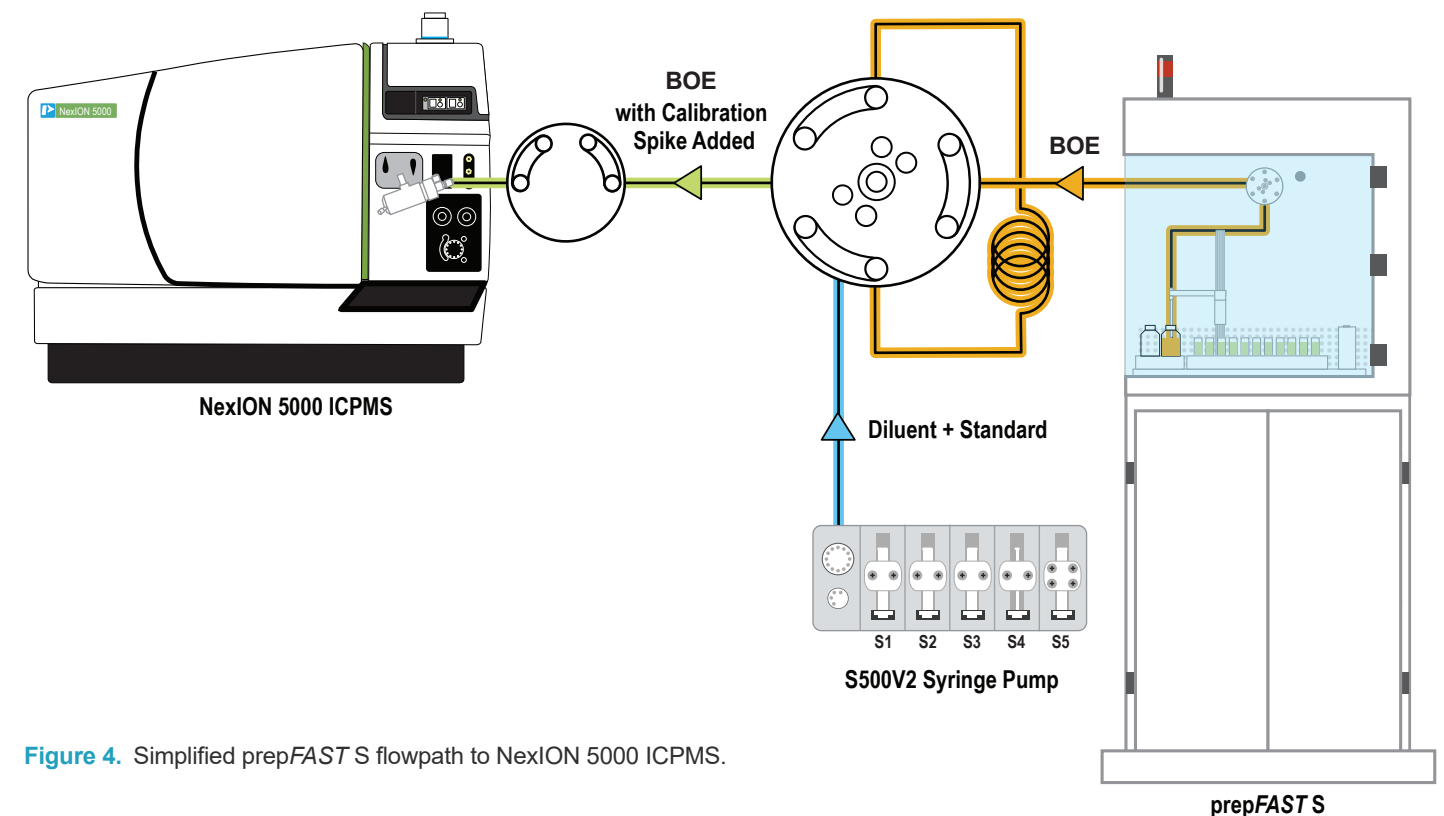

Figure 4. Simplified prepFAST S flowpath to NexION 5000 ICPMS.

Experimental: Reagents and Samples

Commercially available BOE was used as sample for all analyses. A 200 ppt, 1% HNO₃ mixed-element standard was prepared from a 100 ppb standard; Si, S, and P were spiked at 200 ppb. All samples and standards were automatically spiked in-line to a final concentration of 0.5% HNO₃ from an on-board reagent supply vessel (containing 70% HNO₃), to match the sample to the calibration standard and stabilize the spiked elements.

The prepFAST S utilized syringe-driven flow of ultrapure water, semiconductor grade HNO₃, and standard solution to automate sample and MSA standard preparation. All MSA standards were prepared from the stock solutions automatically by the prepFAST S. UPW was used as the carrier solution, and samples were introduced at 200 µL/min.

Experimental: Instrumentation

The NexION 5000 multi-quadrupole ICPMS was used with the Fluorospray sample introduction kit and a microflow PFA-ICN concentric integrated capillary nebulizer. The NexION 5000 automatically switches between cool, warm, and hot plasma conditions to optimize the analysis of all analytes. Cool plasma works in tandem with the multi-quadrupole technology of the NexION 5000 to reduce polyatomic ion interferences while simultaneously reducing background from the ICPMS interface for elements that can be thermally ionized. Hot plasma ensures ionization of refractory and high ionization-potential elements and maintains high matrix tolerance, allowing for analysis of nearly the entire periodic table. Combining multiple plasma conditions, QQQQ filtering, and DRC technology allows for excellent detection limits and accurate determination of trace metals in semiconductor chemicals. Instrumental parameters and sample introduction hardware are listed in Table 1. NexION method parameters are shown in Table 2. DRC gas flow rates and RPq values were determined experimentally.

Table 1. Operating Parameters BOE Analysis.

Parameter	Cool Plasma (STD)	Cool Plasma (DRC)	Warm Plasma (DRC)	Hot Plasma (DRC)	Hot Plasma (STD)
ICP RF Power (W)	600		1400	1600	
Nebulizer Gas Flow (L/min)	0.92	0.84	0.94	0.98	0.96
Reaction Gas	-	NH ₃	O ₂	NH ₃ or O ₂	-
AMS Gas Flow (L/min)	0.1		0.05		
Auxiliary Gas Flow (L/min)	1.2				
Plasma Gas Flow (L/min)	16				
Sample Flow Rate (mL/min)	0.2				
Nebulizer	Fluoroneb PFA-ICN				
Spray Chamber	Fluorospray PFA				
Torch	SiIQ Ultra High Purity Quartz				
Injector	Fluorobore Straight-bore 2.5 mm Platinum				
ICPMS Cones	Platinum-tipped Sampler and Skimmer with Nickel Hyperskimmer				
Hyperskimmer Voltage	-30	-50	5		
OmniRing Voltage	-220	-210	-160	-165	-165
Inner Target Lens Voltage	6				
Outer Target Lens Voltage	0		-17		

Table 2. ICPMS Analytical Conditions.

Element	Q1 Mass	Q3 Mass	Power (W)	Reaction Gas	Reaction Gas Flow	RPq	Element	Q1 Mass	Q3 Mass	Power (W)	Reaction Gas	Reaction Gas Flow	RPq
Li	7	7	600	NH ₃	0.2	0.45	Rh	103	103	600	-	0	0.25
Be	9	9	1600	-	0	0.25	Ag	107	107	600	-	0	0.25
B	11	11	600	-	0	0.25	Cd	111	111	1600	-	0	0.25
Na	23	23	600	NH ₃	1	0.45	In	115	115	1600	-	0	0.25
Mg	24	24	600	NH ₃	0.6	0.45	Sn	120	120	1600	NH ₃	0.3	0.25
Al	27	27	600	NH ₃	1	0.45	Cs	133	133	1600	-	0	0.25
Si	28	44	1500	O ₂	3	0.1	Ba	138	138	1600	-	0	0.25
S	32	48	1500	O ₂	3	0.1	La	139	139	1600	-	0	0.25
P	31	47	1500	O ₂	3	0.1	Ce	140	140	1600	-	0	0.25
K	39	39	600	NH ₃	0.6	0.8	Pr	141	141	1600	-	0	0.25
Ca	40	40	600	NH ₃	0.6	0.8	Nd	146	146	1600	-	0	0.25
Sc	45	61	1500	O ₂	0.5	0.45	Gd	157	157	1600	-	0	0.25
Ti	48	64	1500	O ₂	0.6	0.45	Tb	159	159	1600	-	0	0.25
V	51	67	1500	O ₂	1	0.45	Dy	164	164	1600	-	0	0.25
Cr	52	52	600	NH ₃	0.2	0.45	Ho	165	165	1600	-	0	0.25
Mn	55	55	600	NH ₃	0.2	0.8	Er	166	166	1600	-	0	0.25
Fe	56	56	600	NH ₃	1	0.8	Tm	169	169	1600	-	0	0.25
Ni	58	58	600	NH ₃	0.3	0.45	Yb	174	174	1600	-	0	0.25
Co	59	59	600	NH ₃	0.6	0.45	Lu	175	175	1600	-	0	0.25
Cu	63	63	600	NH ₃	0.2	0.45	Hf	178	178	1600	-	0	0.25
Zn	64	64	1600	NH ₃	0.2	0.45	Ta	181	181	1600	-	0	0.25
Ga	71	71	600	-	0	0.45	W	184	184	1600	-	0	0.25
As	75	91	1500	O ₂	0.3	0.45	Re	185	185	1600	-	0	0.25
Rb	85	85	600	-	0	0.25	Os	189	189	1600	-	0	0.25
Sr	88	88	1600	-	0	0.25	Ir	193	193	1600	-	0	0.25
Y	89	89	1600	-	0	0.25	Tl	205	205	1600	-	0	0.25
Zr	90	90	1600	-	0	0.25	Pb	208	208	1600	-	0	0.25
Nb	93	93	1600	-	0	0.25	Bi	209	209	1600	-	0	0.25
Mo	98	98	1600	-	0	0.25	U	238	238	1600	-	0	0.25

BOE

Calibrations were automatically performed at 0, 0.5, 1, 2, 5 and 10 ppt (Si 1000x higher)

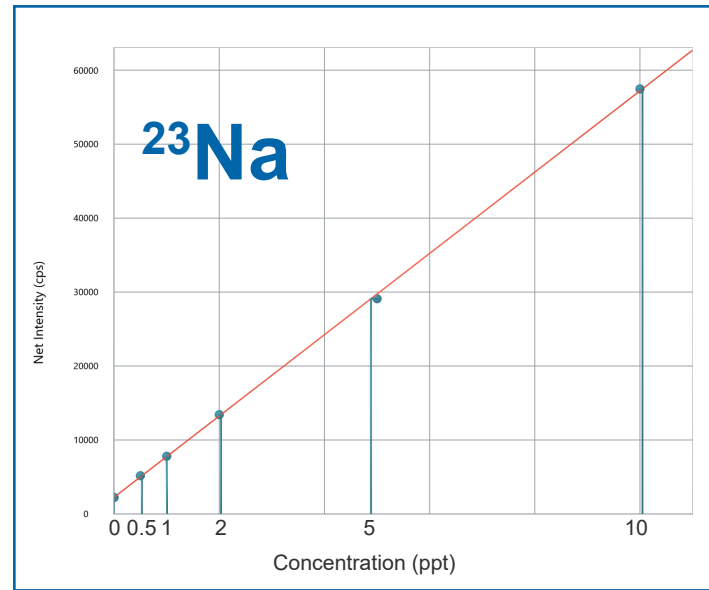

Figure 5

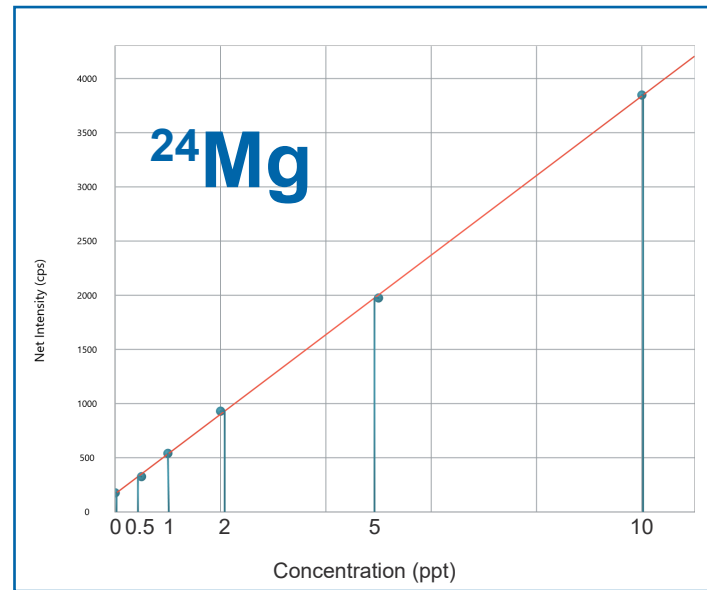

Figure 6

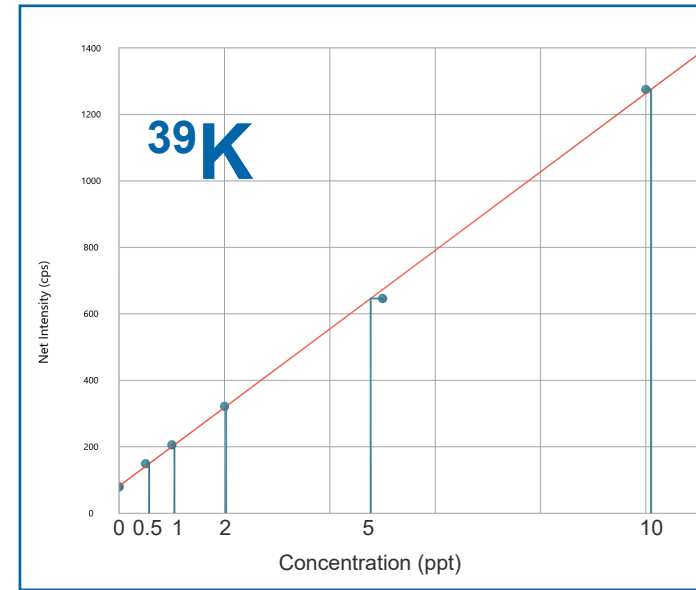

Figure 9

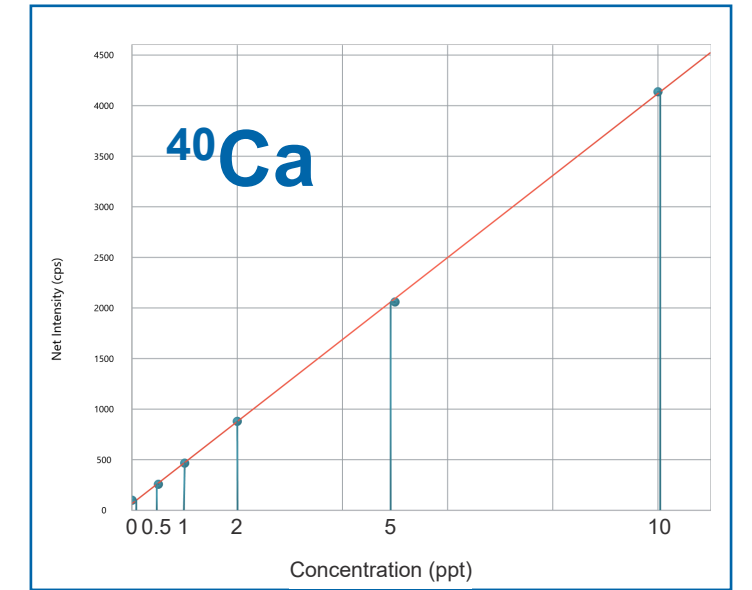

Figure 10

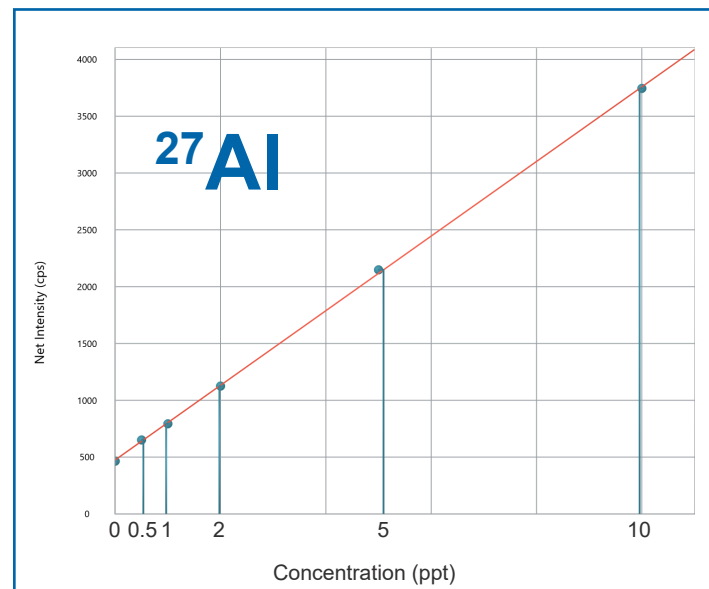

Figure 7

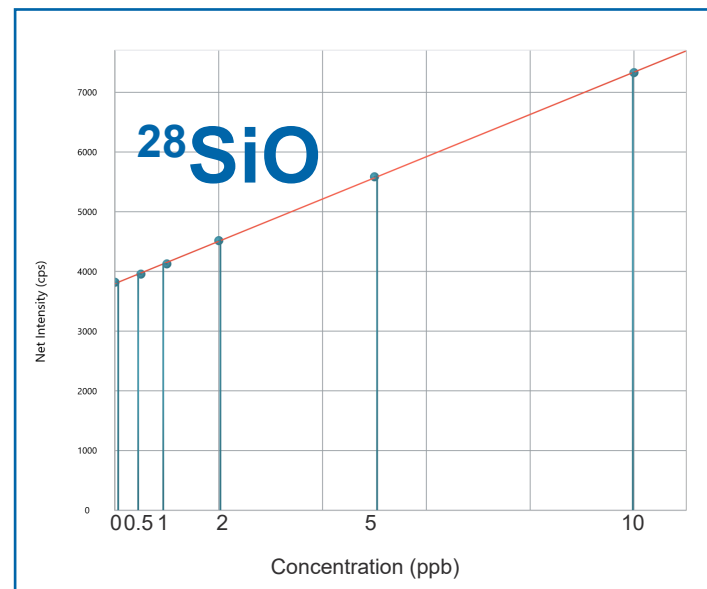

Figure 8

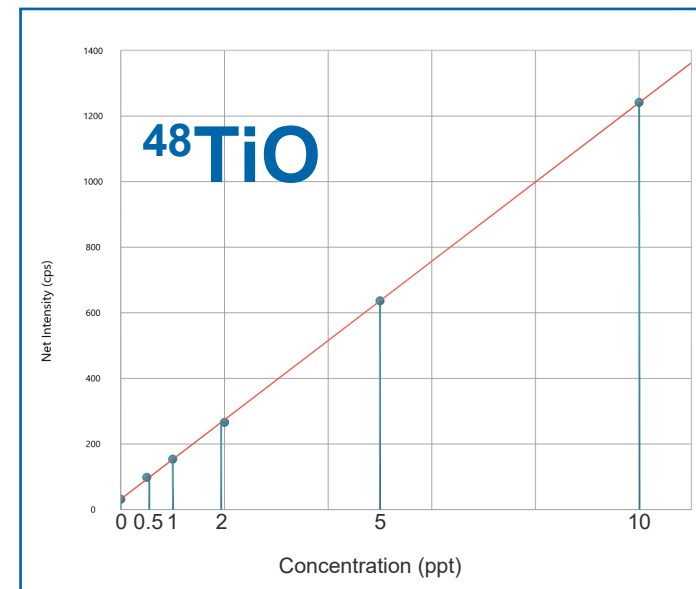

Figure 11

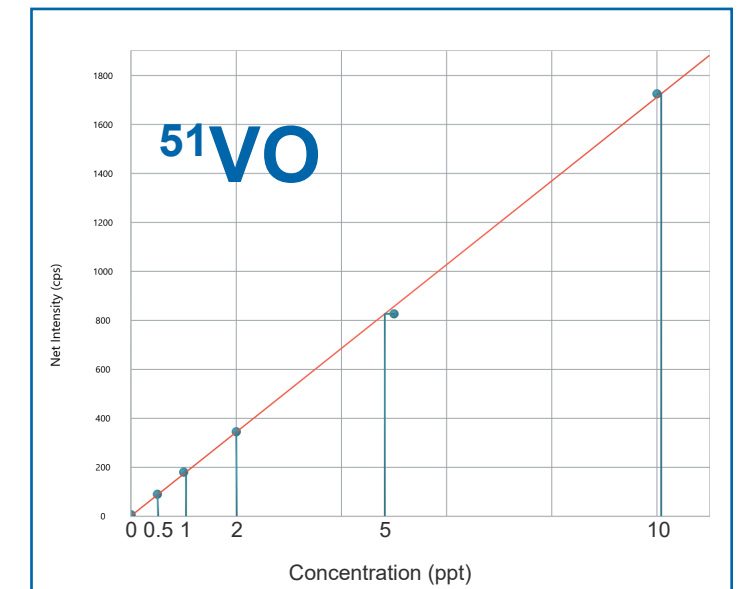

Figure 12

BOE

All calibrations were automatically performed at 0, 0.5, 1, 2, 5 and 10 ppt

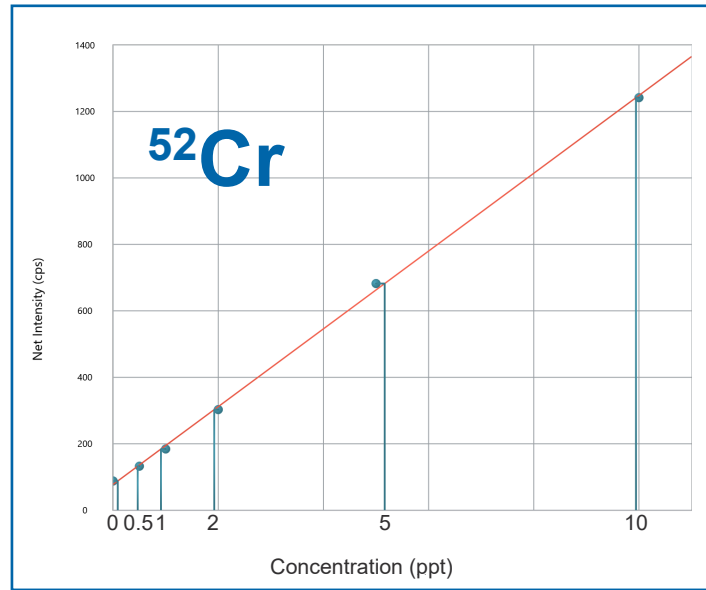

Figure 13

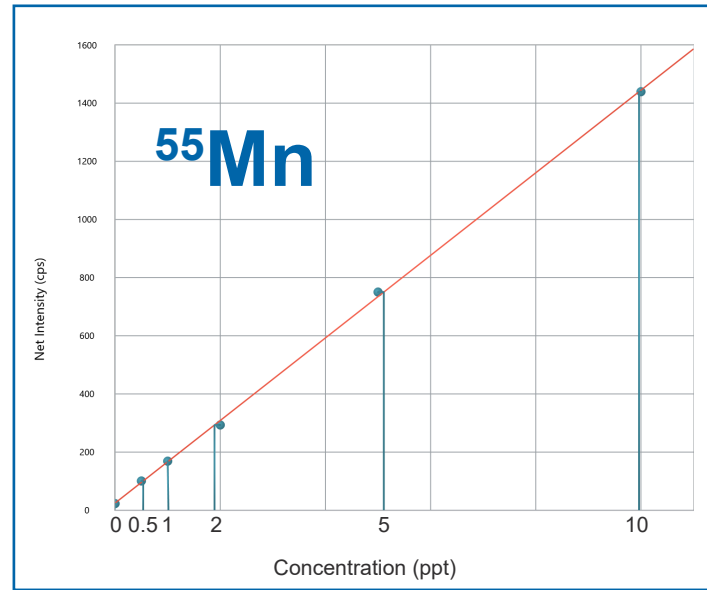

Figure 14

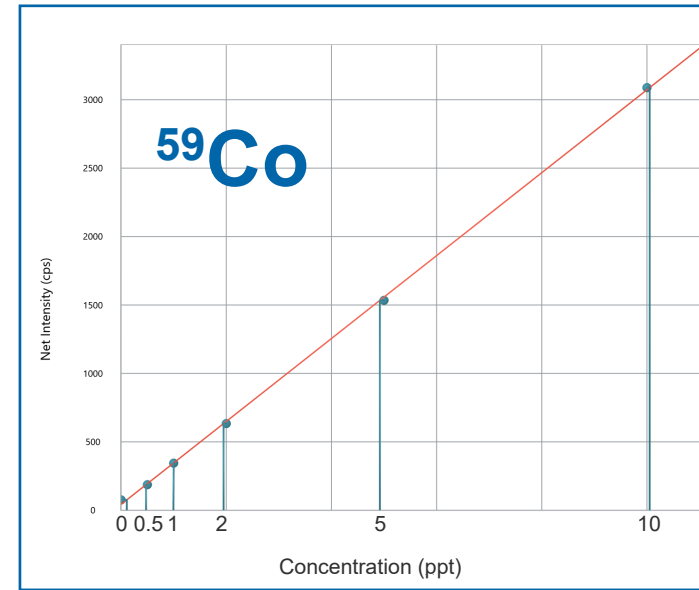

Figure 17

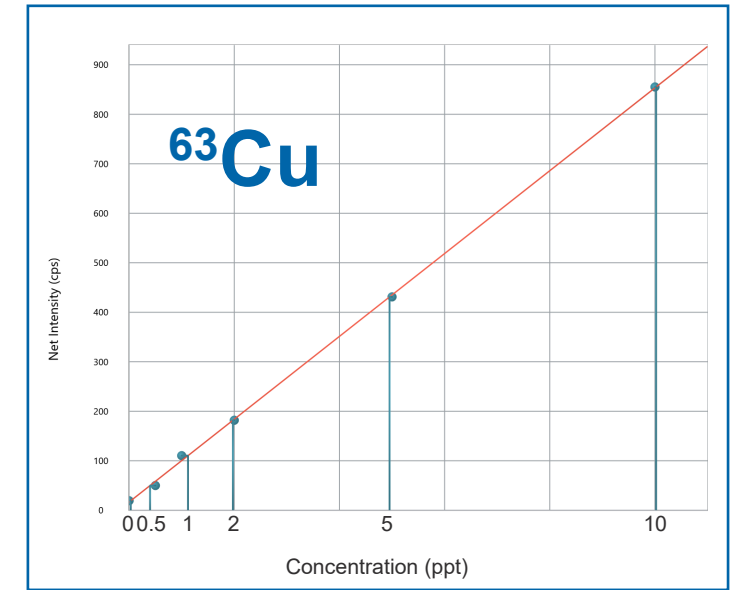

Figure 18

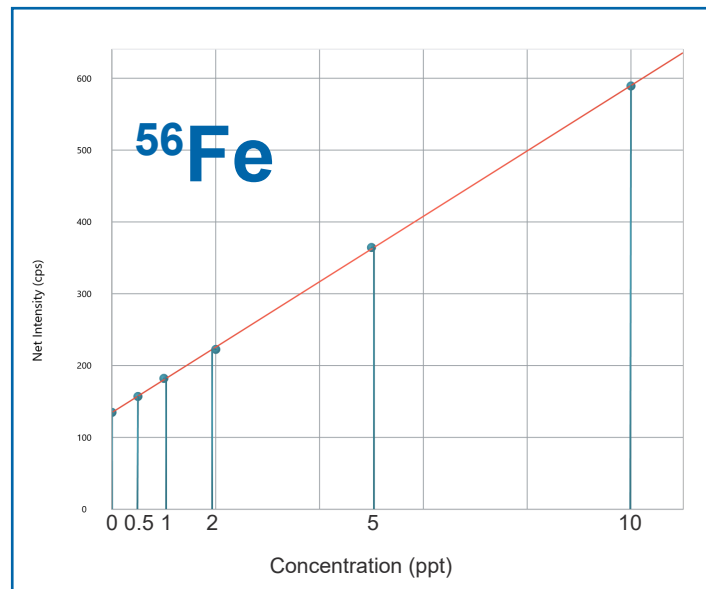

Figure 15

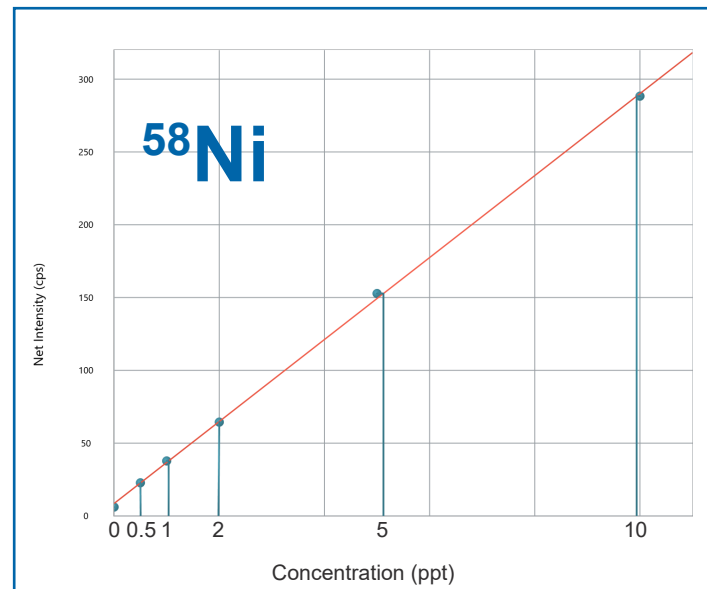

Figure 16

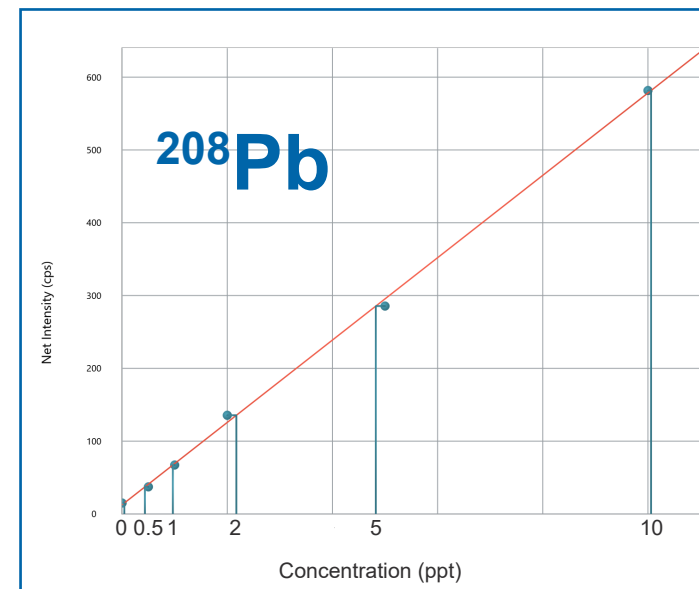

Figure 19

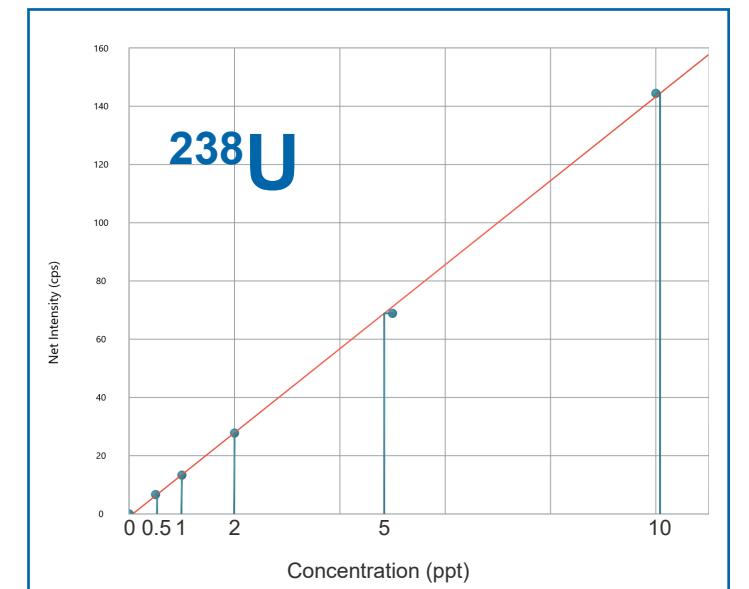

Figure 20

Results and Discussion

Table 3 shows background equivalent concentrations (BEC), limits of detection (LOD), and correlation coefficient (R) for all elements measured in undiluted BOE. Blank subtraction was not used for the determination of BECs or LODs in this study.

Calibrations were automatically prepared at 0, 0.5, 1, 2, 5, and 10 ppt automatically with the prepFAST S (Si, S, and P were spiked at 0, 0.5, 1, 2, 5, and 10 ppb). Figures 5-20 show calibration curves for a selection of elements with MSA in undiluted BOE.

Combining the prepFAST S with the advantages of various plasma modes, QQQQ filtering, and DRC technology allows major contamination-prone elements to be analyzed in the sub-ppt range. These advantages make it possible to achieve sub-ppt or single-digit-ppt BEC and LOD levels for historically difficult elements such as Na, Al, K, Ca, and Fe in undiluted BOE. By utilizing the enclosed and vented sampling area in the prepFAST S, these results were achieved in a non-clean room environment. The correlation coefficients demonstrate the accuracy of the prepFAST S automatic dilution and spike addition, which enables calibrations in complicated matrices with excellent results.

Table 3. BECs, Calibration Linearity, and LODs in BOE.

Element	BEC (ppt)	LOD (ppt)	Linearity (R)	Element	BEC (ppt)	LOD (ppt)	Linearity (R)
Li	0.05	0.02	0.999	Rh	0.02	0.07	0.999
B	5	3	0.996	Ag	0.03	0.07	0.999
Na	0.4	0.2	0.999	In	0.005	0.07	0.999
Mg	0.5	0.3	0.999	Sn	6.1	1.6	0.997
Al	1.5	0.9	0.999	Cs	0.2	0.2	0.999
Si	10.1 (ppb)	1.8 (ppb)	0.999	Ba	0.1	0.1	0.999
S	9.0 (ppb)	3.8 (ppb)	0.999	La	0.06	0.2	0.999
P	6.1 (ppb)	0.9 (ppb)	0.999	Ce	0.06	0.1	0.999
K	0.7	0.6	0.999	Pr	0.06	0.08	0.999
Ca	0.2	0.08	0.999	Nd	0.03	0.3	0.999
Sc	0.05	0.1	0.999	Gd	0.1	0.1	0.999
Ti	0.3	0.1	0.999	Tb	0.02	0.08	0.999
V	0.01	0.08	0.999	Dy	0.08	0.2	0.999
Cr	0.7	0.3	0.999	Ho	0.05	0.1	0.999
Mn	0.2	0.1	0.999	Er	0.1	0.06	0.999
Fe	2.9	1.2	0.999	Tm	0.05	0.08	0.999
Ni	0.3	0.4	0.999	Yb	0.01	0.09	0.999
Co	0.1	0.05	0.999	Lu	0.01	0.06	0.999
Cu	0.2	0.3	0.999	Hf	0.05	0.1	0.999
Zn	3.4	0.5	0.995	Ta	0.02	0.2	0.999
Ga	0.03	0.07	0.999	W	0.1	0.3	0.999
As	3.5	2.4	0.999	Re	0.1	0.2	0.999
Rb	0.02	0.04	0.999	Os	0.7	0.5	0.999
Sr	0.1	0.09	0.999	Ir	0.09	0.06	0.999
Y	0.05	0.05	0.999	Pb	0.2	0.2	0.999

Conclusions

Fully automated analysis of Buffered Oxide Etchant samples was performed using the prepFAST S and NexION 5000 Triple Quad ICPMS. The automated dilution and MSA calibration capabilities of the prepFAST S achieved linear calibration curves for all elements analyzed. The triple quadrupole ICPMS allowed for elimination of key polyatomic interferences, and detection limits for 50 elements were sub-ppt, while Si, P, and S were low to sub-ppb.

Summary

prepFAST S fully automates sample analysis in an ultraclean enclosed system:

- Offers ultrapure semiconductor-grade chemical preparation, dilution, and analysis with detection limits in ppt/ppq range with ICPMS
 - Allows for direct analysis of concentrated chemicals without pre-dilution
- Automatically performs calibration using MSA or external calibration
- Includes a magnetically coupled PTFE/CTFE drive as part of the most chemically resistant autosampler on the market
- Utilizes SampleSense valve to detect all samples – viscous, non-viscous, solvents – without timing or method adjustment

